

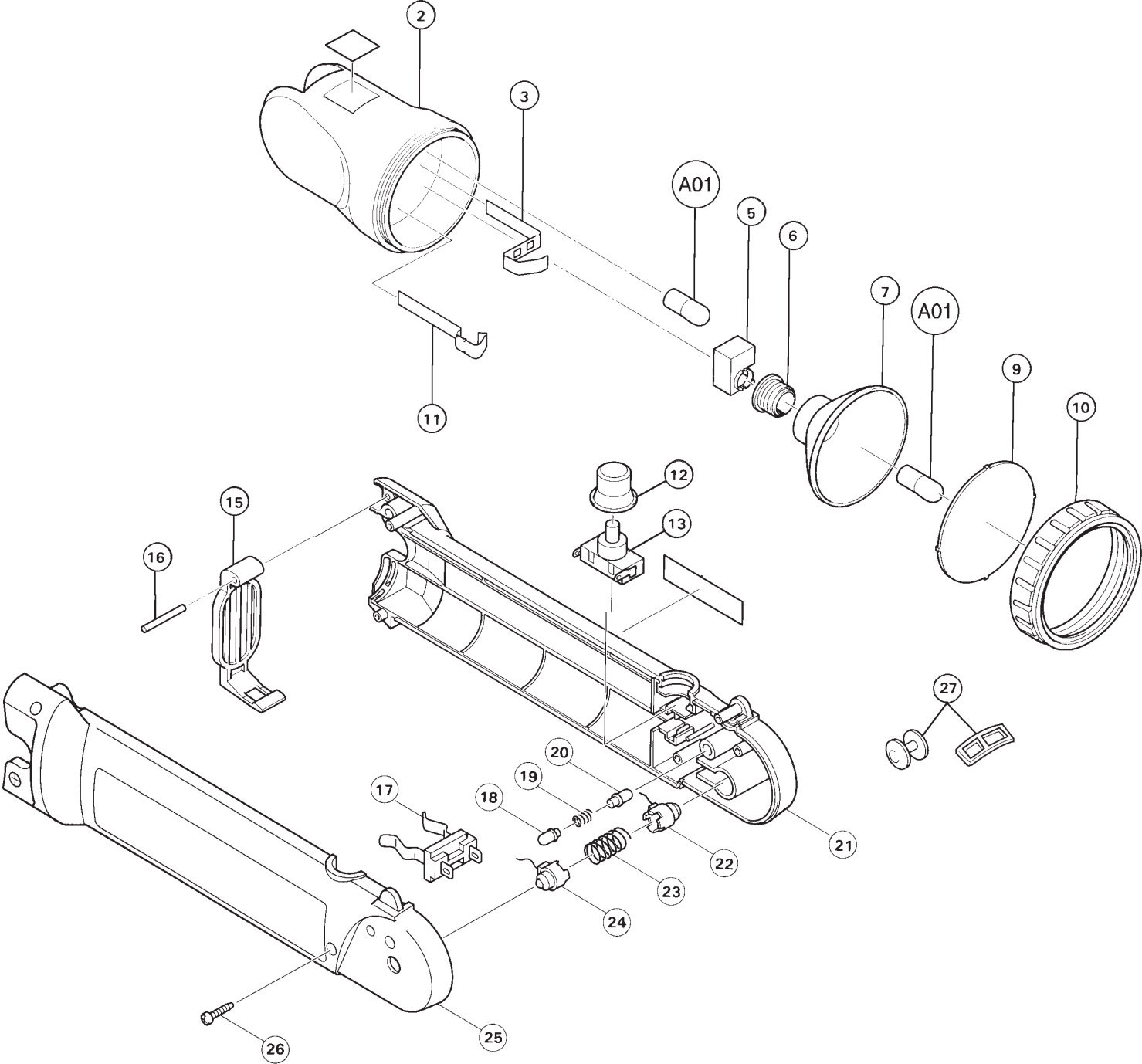

03 - 2010
ML902
9.6V FLASHLIGHT



Item No	Type	Sub	Part No.	Description	Qty	Unit
2			415760-5	CASE HEAD	1	PC.
3			654136-3	BULB CONTACT PLATE A	1	PC.
5			415810-6	PROTECTOR	1	PC.
6			415855-4	BULB HOLDER	1	PC.
7			163368-6	REFLECTOR	1	PC.
9			415866-9	LENS	1	PC.
10			415807-5	REFLECTOR RETAINER	1	PC.
11			654137-1	BULB CONTACT PLATE B	1	PC.
12			421540-9	COVER	1	PC.
13			651709-3	SWITCH	1	PC.
15			344549-3	SET PLATE (STEEL) TYPE 2	1	PC.
16			256252-3	PIN (OLD# 256133-1 - N/L/A)	1	PC.
17			643926-9	BATTERY HOLDER	1	PC.
18			415811-4	KNOCK SHAFT	1	PC.
19			233143-5	SPRING	1	PC.
20			415811-4	KNOCK SHAFT	1	PC.
21			415867-7	HOUSING (L)	1	PC.
22			632533-3	PIVOT TERMINAL UNIT L	1	PC.
23			233144-3	SPRING	1	PC.
24			632524-4	PIVOT TERMINAL UNIT R	1	PC.
25			415868-5	HOUSING (R)	1	PC.
26			265869-1	SCREW	4	PC.
27	1		415812-2	HOOK BUTTON (Use with Item No. A02 Type1) - N/L/A	2	PC.
	2		345261-8	HOOK PLATE (Use with Item No. A02 Type2)	2	PC.
28			655000-B	CIGARETTE LIGHTER PLUG	1	PC.

ACCESSORIES

A01			192545-3	BULB 2PC/SET (OLD# 192546-1 - N/L/A)	1	SET
A02	1		415813-0	STRAP (Use with Item No.27 Type1)	1	PC.
	2		417926-3	STRAP (Use with Item No.27 Type2)	1	PC.
A03			632007-4	9.6V NI-CAD BTTRY 9000	1	PC.
			192533-0	9.6V NI-CAD BTTRY 9002	1	PC.
A04			414938-7	BATTERY COVER	1	PC.
A05			DC1414	CHARGER DC1414	1	PC.
			DC1804	CHARGER DC1804	1	PC.
			DC1822	AUTOMOTIVE CHARGER DC1822	1	PC.